

Tank Fittings



Bolted Tank Flanges	196
Threaded Bulk Head Fittings	196
Jet Agitators	197
Anti-Vortex Fittings	197
Fluid Powered Mixers	197
Tank Lids	198 - 200
Basket Filters	199 - 200

Tank Bulk Head Fittings

Bolted Tank Flanges



Part No.	Outlet Thread	Inlet Thread
9901-BF100	1" F	1" F
9901-BF125	1 1/4" F	1" F
9901-BF150	1 1/2" F	2" F
9901-BF200	2" F	2" F
9901-BF300	3" NPTF	3" NPTF

- Stainless steel fasteners
- EPDM gaskets as standard
- Polypropylene construction

Bottom Drain Flanges



Part No.	Outlet Thread	Inlet Thread
9901-BF075BD	3/4" F	1" F
9901-BF100BD	1" F	1" F
9901-BF150BD	1 1/2" F	2" F
9901-BF200BD	2" F	2" F
9901-BF300BD	3" NPTF	3" NPTF

- Stainless steel fasteners
- EPDM gaskets as standard
- Polypropylene construction

EPDM Gaskets for Bolted Flanges



Part No.	Fits size	Material
9901-BF100GE	3/4" 1" 1 1/4"	EPDM
9901-BF200GE	1 1/2" & 2"	EPDM
9901-BF300GE	3"	EPDM

Viton Gaskets for Bolted Flanges



Part No.	Fits size	Material
9901-BF100GV	3/4" 1" 1 1/4"	Viton
9901-BF200GV	1 1/2" & 2"	Viton
9901-BF300GV	3"	Viton

Complete Outlet - Threaded - 805 Series



Part No.	Thread Ø x L	Thread
8051151	14 x 43.5mm	1/2" M
8051201	18 x 43.5mm	3/4" M
8051251	25 x 50mm	1" M
8051301	32 x 40mm	1 1/4" M
8051302	32 x 48mm	1 1/4" M
8051351	38 x 45mm	1 1/2" M
8051401	47 x 64mm	2" M

- Polypropylene construction

Outlet - Male Thread Only - 805 Series



Part No.	Thread Ø x L	Thread
8050151	14 x 43.5mm	1/2" M
8050201	18 x 43.5mm	3/4" M
8050251	25 x 50mm	1" M
8050301	32 x 40mm	1 1/4" M
8050302	32 x 48mm	1 1/4" M
8050351	38 x 45mm	1 1/2" M
8050401	47 x 64mm	2" M

- Polypropylene construction

Gaskets for 805 Series - EPDM



Part No.	Fits M Thread
G00002008	1/2"
G00002010	3/4"
G00002012	1"
G00002014	1 1/4"
G00002016	1 1/2"
G00002018	2"

Threaded Bulkhead Fitting - BH Series



Part No.	Thread	Hole
9902-BH12	1/2" F	1 5/8"
9902-BH34	3/4" F	1 5/8"
9902-BH100	1" F	2 1/16"
9902-BH114	1 1/4" F	2 1/2"
9902-BH112	1 1/2" F	2 1/2"
9902-BH200	2" F	3 1/8"
9902-BH300	3" F (NPT)	4 1/4"

- EPDM gaskets as standard
- Polypropylene construction

Threaded Bulkhead Fitting - TF Series



Part No.	Thread	Hole
9901-TF050	1/2" F	1 5/8"
9901-TF075	3/4" F	1 5/8"
9901-TF100	1" F	2 1/4"
9901-TF125	1 1/4" F	2 1/4"
9901-TF150	1 1/2" F	3"
9901-TF200	2" F	3"
9901-TF220	2" F	3 1/4"
9901-TF300	3" F (NPT)	4 1/2"

- EPDM gaskets as standard
- Polypropylene construction

Gaskets for TF Series



Part No.	Fits size	Material
9901-150G	1/2" & 3/4"	EPDM
9901-200G	1" & 1 1/4"	EPDM
9901-300G	1 1/2" & 2"	EPDM
9901-150GV	1/2" & 3/4"	Viton
9901-200GV	1" & 1 1/4"	Viton
9901-300GV	1 1/2" & 2"	Viton
9901-150GB	1/2" & 3/4"	Buna
9901-200GB	1" & 1 1/4"	Buna
9901-300GB	1 1/2" & 2"	Buna

Jet Agitators & Vortex Fittings

Jet Agitators - Straight Inlet

Part No.	Nozzle Ø	Thread
8201000	1.2mm	1/2" M
8201001	1.5mm	1/2" M
8201002	2mm	1/2" M
8201003	3mm	1/2" M

- Polypropylene with ceramic nozzle
- Max flow 240 Lpm - Max press 40 Bar



Jet Agitators - 90° Inlet

Part No.	Nozzle Ø	Thread
8201004	1.2mm	1/2" M
8201005	1.5mm	1/2" M
8201006	2mm	1/2" M
8201007	3mm	1/2" M

- Polypropylene with ceramic nozzle
- Max flow 240 Lpm - Max press 40 Bar



Hypro Jet Agitator

Part No.
3371-0019

- Polypropylene construction
- 3/4" Male thread inlet
- Supplied with 3 jet sizes



Hypro Jet Agitator

Part No.
3371

- Polypropylene construction
- 1/2" Female thread inlet
- 3/4" Male thread outlet
- Supplied with 3 jet sizes



High Volume Agitator

Part No.	Nozzle
8201010	2mm - ceramic
8201011	3mm - ceramic
8201012	5mm - S/Steel

- Max press 40 Bar
- Max flow 700 Lpm
- Polypropylene construction
- 1/2" Male thread



Anti-Vortex Suction Fitting

Part No.	Barb
8209000	25mm
8209001	30mm
8209002	35mm
8209003	40mm
8209004	45mm

- Polypropylene construction
- 3/4" M thread
- 2" F backnut



Siphon Tubes

Part No.	Thread
9901-ST200	2" M
9901-ST300	3" NPTM

- Polypropylene construction



Vent / Anti-Vortex Cap

Part No.	Thread	Description
9901-VC230	2" M	With Screen
9901-VC200	2" M	Without Screen
9901-VC300	3" NPTM	Without Screen

- Can be used as a vent cap or anti-vortex fitting
- Polypropylene - AISI 304 S/Steel screen (optional)



Fluid Powered Mixer - Polypropylene

Part No.
8199000

- Polypropylene construction
- Maximum pressure 5 Bar
- 1/2" BSPM inlet
- Elbow connects to the main body via 3/4" BSPM thread



Fluid Powered Mixer - Stainless Steel

Part No.
8199001

- Stainless steel & brass construction
- Maximum pressure 5 Bar
- 1/2" BSPM inlet
- 1/2" BSPM bulkhead fitting with nuts

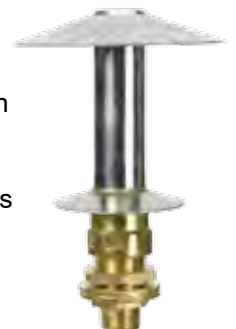

Tank Lids & Basket Filters

- Manufactured in Polypropylene with AISI 304 stainless steel parts.
- EPDM gaskets (Viton on demand)

100 Series Tank Lids & Accessories



Threaded - o-ring not included	
Part No.	Description
8178002	No vent

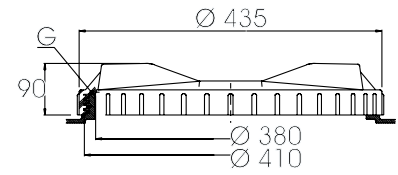

Threaded - o-ring not included				
Part No.	Description	A	B	C
8178000	No vent	172 mm	6"	56 mm
8178001	1 NRV with spring	172 mm	6"	56 mm
G00001066	Replacement o-ring			

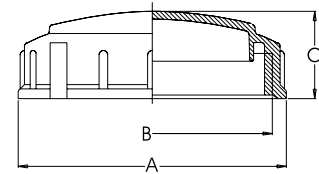

Threaded - o-ring not included				
Part No.	Description	A mm	B mm	C mm
8178004	No vent	240	226	55
8178005	EPDM Valve	240	226	55
8178006	1 NRV with spring	240	226	55
G00001075	o-ring for all above lids			

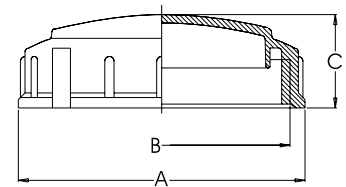

Rubber lids with suction valve		
Part No.	A mm	B mm
8184000	265	20
8184001	365	20
8184002	454	22

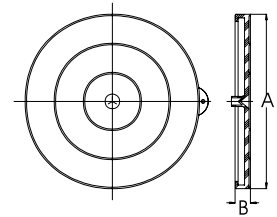

140 Series Tank Lids & Accessories



Manta 140 series - threaded					
Part No.	Description	A mm	B mm	C mm	D mm
8140000	No vent	140	120	8	n/a
8140001	2 NRV with springs	140	120	8	52.5
8140002	2 vents	140	120	8	52.5
8140003	4 vents	140	120	8	52.5

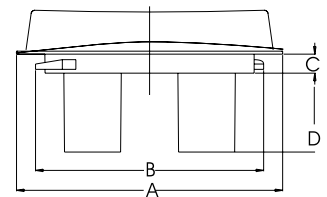

Tank lid ring for Manta 140 series					
Part No.	Description	A mm	B mm	C mm	L mm
8142000	No o-ring	154	125	112	17
G00000000	o-ring for above ring				

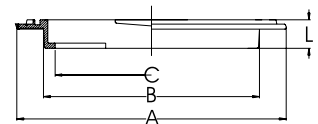

255 Series Tank Lids & Accessories



Manta 255 series - threaded				
Part No.	Description	A mm	B mm	C mm
8146000	No valve	250	210	31
8146001	Non return valve	250	210	31
8146002	Vented	250	210	31

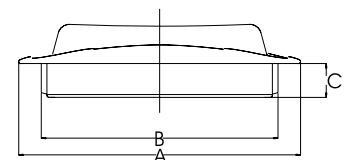

Tank Lids & Basket Filters

255 Series Tank Lids & Accessories

Tank lid rings for 255 Manta series						
Part No.	Description	A mm	B mm	C mm	L mm	D mm
8148000	Plain hole	262	217	192	39	n/a
8148001	Plain hole with lip	262	217	192	39	230
8148002	Fitted with o-ring	265	217	192	39	n/a
G0000001	Replacement o-ring for 8148002					

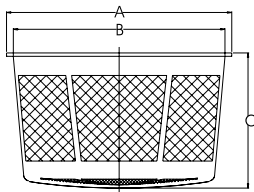
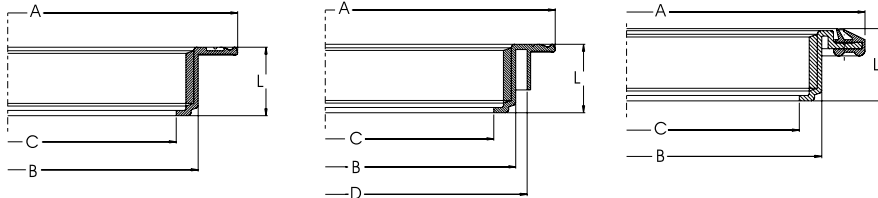

Basket filters for 255 Manta series				
Part No.	Description	A mm	B mm	C mm
8147000	Suitable for all Manta 255 series	201	189	50
8147001		201	189	120
8147002		201	189	240



355 Series Tank Lids & Accessories

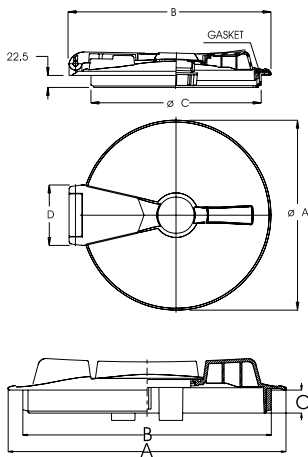

Abat 355 series - hinged with integrated tank ring & lid o-ring						
Part No.	Description	A mm	B mm	C mm	D mm	
8169014	With vent	357	381	320	114	
8170015	With vent	457	480	415	125	



Manta 355 series - threaded				
Part No.	Description	A mm	B mm	C mm
8152000	No vent	350	313	29
8152001	2 NRV with springs	350	313	29
8152002	2 vents	350	313	29
8152003	4 vents	350	313	29
8152004	1 vent	350	313	29
8152005	PVC NRV	350	313	29



Tank rings for Manta 355 series						
Part No.	Description	A mm	B mm	C mm	L mm	D mm
8154000	Plain hole	357	320	290	38	n/a
8154001	Plain hole with lip	357	320	290	38	335
8154002	Fitted with o-ring	368	320	290	38	n/a
G0000002	Replacement o-ring for 8154002					

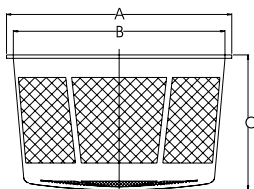
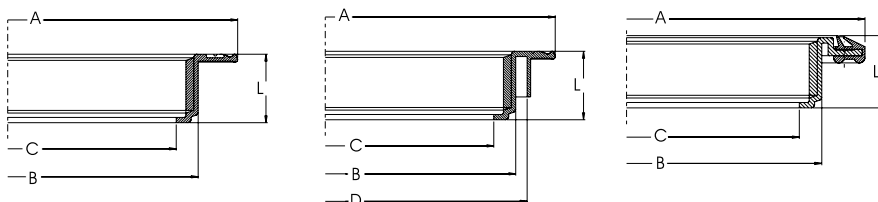

Basket filters for 355 series lids				
Part No.	Description	A mm	B mm	C mm
8153000	Suitable for all	301	287	60
8153001	Manta 355 series	301	287	240



Tank Lids & Basket Filters

455 Series Tank Lids & Accessories



Manta 455 series - threaded lids					
Part No.	Description	A mm	B mm	C mm	
8158000	No vent	450	408	23	
8158001	2 rubber NRV	450	408	23	
8158002	2 vents	450	408	23	
8158003	4 vents	450	408	23	
8158004	PVC NRV	450	408	23	
8158005	1 vent	450	408	23	

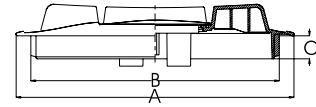

Tank rings for Manta 455 series						
Part No.	Description	A mm	B mm	C mm	L mm	D mm
8160000	Plain hole	457	415	382	35	n/a
8160001	Plain hole with lip	457	415	382	35	430
8160002	Fitted with o-ring	463	415	380	35	n/a
G00000003	Replacement o-ring for 8160002					

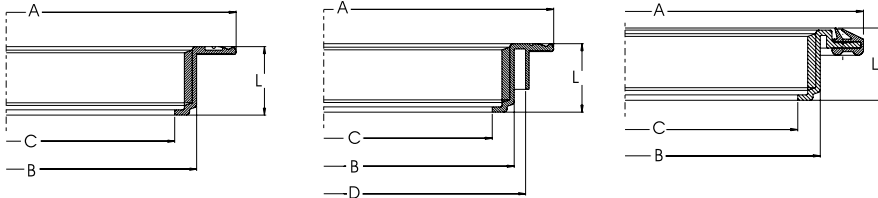

Basket filters for 455 series lids				
Part No.	Description	A mm	B mm	C mm
8159000	Polypropylene	400	380	180
8159001		400	380	280
8159002		400	380	320

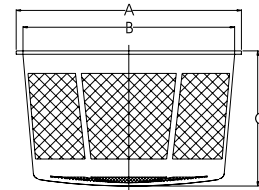

EPDM Air Valve



Part No.	Description
V00101000	Fits all lids with rubber valves

- 33 mm Ø

Tank Cleaners



Page 147-151

Tank Cleaners



Page 147-151

Tank Cleaners



Page 147-151